

Language: **English**



User manual

Model: SWR1010
Manual version: 2.4

www.vektiva.com



Introduction

Congratulations on your purchase.

Thanks to SMARWI, you can effectively control the flow of fresh air into the rooms, control your windows and contribute to improving the quality of your everyday life.

For important safety information, see Chapter 4. [Safety instructions.](#)

You can find more detailed information about SMARWI (instructional videos, expanded usage examples, and more) at <http://www.vektiva.com>.

Content

1. Package content	2
2. Device description	3
3. SMARWI compatible windows.....	3
4. Safety instructions.....	5
5. Installation	6
6. Control & maintenance	12
7. Examples of use	16
8. Disposal instructions.....	16
9. Warranty	16
10. Technical specifications	17
11. Service & accessories.....	18

1. Package content

Package content:

- SMARWI (device including holder) and Safety control Box (ScB) connected by cable
- Ridge including holder
- Power adapter
- Installation kit comprising: adhesive tapes for all holders and Safety control Box, 6x screw for drilling into the window, 2x screw cap, 8x cable holder
- User manual

2. Device description

This device is designed to work with Tilt-Turn Windows commonly used in Europe. SMARWI allows you to regulate the opening angle of ventilation and ventilate at predetermined moments. Using Wi-Fi connectivity, SMARWI can be controlled from mobile devices. Once connected to your home network under your account, you'll be able to control SMARWI online even when you're on the move or at work.

Thanks to the ability to regulate ventilation remotely and according to predefined rules, SMARWI is an effective in solving many situations that would require your physical presence near a given window. See [Chapter 7 for more examples of use](#).

SMARWI is an electrotechnical device that meets EU legislative requirements (CE). Its detailed technical specification can be found in [Chapter 10. Technical specifications](#).

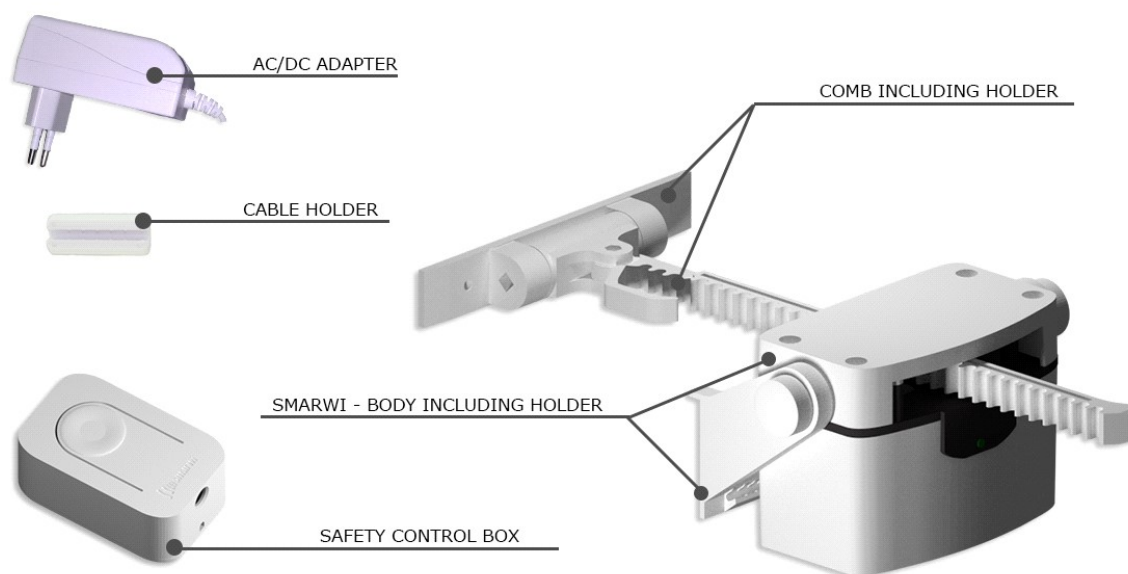

Figure #1: SMARWI parts

3. SMARWI compatible windows

SMARWI controls the opening angle of ventilation, so it is designed exclusively for Tilt-Turn Windows operation, see Figure # 2A.

To install SMARWI the window must meet certain minimum size requirements (Figure # 2B). Smooth run of ventilation movement is necessary to operate large windows and doors.

SMARWI can be with respect to min. dimensions installed on the Tilt-Turn windows with right and left side opening.



Figure #2A: SMARWI compatible window example

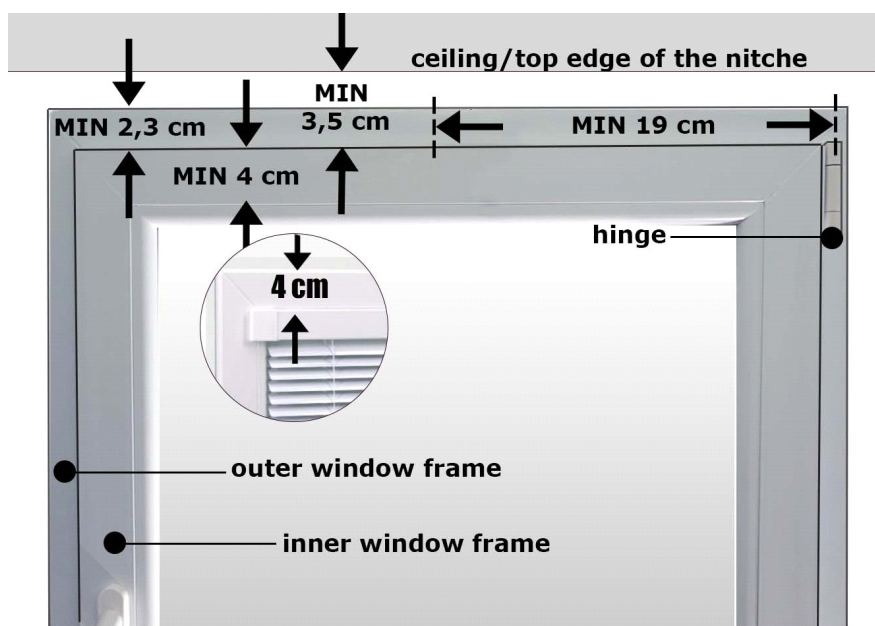

Figure #2B: Minimal dimension requirements









If blinds are installed on the window (Figure # 2B), make sure there is enough space on the outer frame to attach the SMARWI holder (min. 4 cm)

4. Safety instructions









Please keep the original "User manual" carefully. Observe safety instructions manipulation & work with SMARWI to avoid the risk of injury to yourself or others.











Instructions indicated in the manual with warning symbols:

-  be aware of threats to health or damage to property
-  important information for operator
-  general information for operator

-   The operator must always disconnect the appliance from all sources of energy during adjustment, maintenance and repairs.
-   Operator is required to read user manual

During SMARWI installation & operation please observe the following safety instructions:

-  This device is intended for indoor use only with the Tilt-Turn window type and for ventilation control of windows in ventilation mode.
-  When closing a window with SMARWI in the ventilation mode, there is a risk of injury to a part of the body caught between the window and the frame (in the case of wind / draft shut-off or unintentional manipulation). To immediately interrupt closing, press the button on the safety control box. SMARWI immediately releases the window. For more information on the functions of the safety control button, refer to [Chapter 6. Control and Maintenance](#).
-  SMARWI is controlled via a remote controller (mobile device, PC) or ScB.
-  Before performing any work, the operator must check the equipment for signs of damage or other dysfunction that could endanger the health or property
-  The appliance is not intended for use by persons (including children) with reduced mental or physical fitness or lack of experience and knowledge until they are guided or trained in the use of this appliance by a person responsible for their safety.
-  Place the power adapter in a socket and avoid contact with water.
-  Avoid using SMARWI if the window is blocked, opens with excessive force, the ventilation opening is locked or there is a force preventing its free movement. Using SMARWI in this case can cause permanent damage.
-  In case of strong wind/draft, the ventilation position can shift or the window may open/closed unintentionally. Window's security and function is the same as in normal ventilation mode without SMARWI installed. In cases of strong winds, it is recommended to turn off the SMARWI and ensure that the window is in the normal way

-  Do not attempt to operate the device unless you have read all the instructions supplied by the manufacturer and you understand the procedure!!
-  SMARWI does not change window security and prevent from unauthorized intrusion. Window security remains the same as without SMARWI installed.
-  It is forbidden to remove or deactivate Safety control Box.
-  It is forbidden to touch moving parts of the device with part of body objects or tools.
-  Using a non-supervised appliance in a room where small children, persons with reduced mental ability or animals can access the window (as in the case of window shut-off or careless manipulation) can cause injury. Avoidance of these circumstances is fully within the competence of the person responsible for their safety.
-  Accessories not recommended by the manufacturer may cause injury and will void the warranty.
-  During manual window manipulation, always release SMARWI by pushing the ScB button. While manually opening window proceed slowly, and prevent damage to the ridge when racing outside the device slot.
-  Do not use this appliance with damaged supply cord or plug or if the appliance appears to be damaged in any way. Make sure that the damaged cable or plug is replaced by an authorized service center. Do not repair this appliance yourself. All repairs should be carried out by a competent qualified service (see [Chapter 10.Services and accessories](#)).
-  In case of instruction avoidance manufacturer is not responsible for any damage
-  Make sure that the voltage on the adapter label supplied with the device matches the voltage in your home's electrical network. Rated voltage: ST220-240V 50Hz. The socket must be protected by a circuit breaker for a minimum current load of 6A
-  Only use original spare parts from the manufacturer.

5. Installation

Before installation, please read the information in [Chapter 4.Safety Instructions](#). Using the device improperly and inconsistently with the installation instructions can cause personal injury to the person handling the window, damage to the device itself, and loss of warranty.

SMARWI is design for DIY (do it yourself) installation at your home without the need for drilling using pre-prepared adhesive tapes. The adhesive tape can be used on the smooth surface of both plastic and wooden windows. If necessary, holders can be additionally fastened using the attached screws. SMARWI can be installed on both right and left opening windows.



Important note: The correct positioning and pasting of SMARWI holders as well as their precise positioning, has a major impact on the quality of the device operation. The entire SMARWI installation takes place when the window is closed. Pay attention, just as you do when washing windows, exercise caution, apply the necessary safety precautions to avoid injuries.

Installation procedure:



Make sure the window you want to control with SMARWI has a smooth moving ventilation without jamming or the need to use excessive force to close / open it.

Turn the window crank into the ventilation position and open/close the window into full ventilation. If you experience problems with scrubbing or you need strong force, lubricate it adjust according to the manufacturer's instructions or contact a qualified service center.

The first step is to install the ridge holder, see points 1-5. If it is necessary to fix it with the screws, follow the procedure of attaching the holder according to step #5, otherwise skip this step.



Important note: Use the screws if your window has an uneven surface (e.g. some older wooden windows). The adhesive tape used is of high quality and allows long-term attachment to most common plastic windows and smooth surface windows without the need for screws.

- 1) Select the right location for SMARWI installation (Figure # 3A) and mark it with a pencil on the outer frame of the window. Ideal location of SMARWI is in the middle of the top edge of the window. The power distribution will be optimal and even.

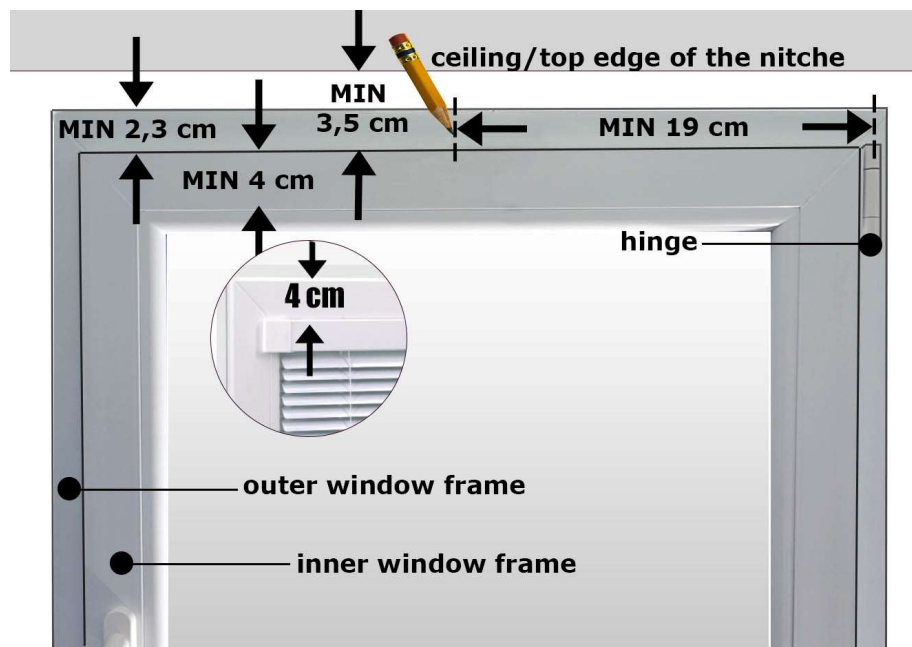

Figure #3A: Mark the SMARWI holder



Important note: Apply following steps on dry & clean surface. Before SMARWI installation remove grease, clean & dry both inner and outer window frame. The strength and ultimate reliability with which

the SMARWI adhesive tape will hold depends on the quality and smoothness of the window surface. In case of an uneven or unstable window surface, select the additional attachment using the screws.



Important note: For small size windows, it may not be possible to place SMARWI in the center, but it is necessary to place it at least 19 cm from the window hinges. Not respecting the minimum distance will limit window opening to the side and may damage the device. In order to fix properly the ridge holder upper frame of the window must have a minimum height of 2.3 cm.



Important note: To peel off the corner of adhesive tape, use your nail or the tip of a thin knife.

- 2) Remove the adhesive foil cover on the back of the ridge holder (Figure # 3B).



Figure #3B: Adhesive tape cover removal

- 3) Paste the ridge holder in the middle of the marked area (the center of the outer frame) parallel to the edge of the window, approximately 0-2mm above the top edge of the closed window (Figure # 3C). Ensure correct teeth orientation of the ridge.

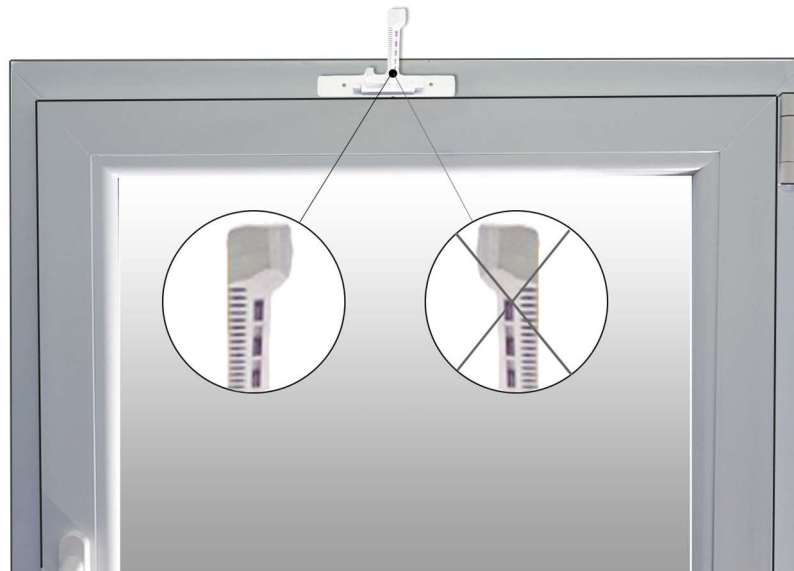

Figure #3C: SMARWI holder stuck in the middle of the window frame, tightly above the upper edge of the inner frame. The orientation of ridge teeth always on the left



Important note: Prior to gluing, be careful about the correct orientation of the ridge. The teeth of the ridge are always pointing to your left hand (from your point of view), regardless of whether you are installing on windows with hinges on the right or left

- 4) Mark the right edge of the ridge of the SMARWI bracket on the inner frame of the window (Figure # 3D). We will match SMARWI with this mark when gluing in the next step

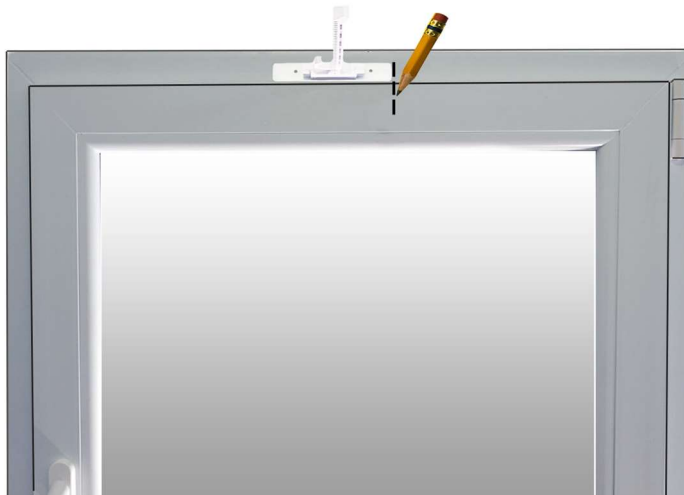

Figure #3D : Create mark to stick the ridge

- 5) If required, fasten the ridge holder using the screws, twisting them through the openings on both sides of the holder. Attach the caps on fixed screws to hide them.

Now we have glued the ridge. The procedure for installing SMARWI (device with holder) is described in points 6-9.

If you will need additional fixing by screws, follow step no. 9, otherwise omit this point.

- 6) **First try the gluing procedure described in points 7 and 8 without removing the stick foil.** Once you handle the procedure, remove adhesive foil cover from sticker on the back of the SMARWI holder the same way you did with the ridge holder.
- 7) Keep the window closed and insert ridge tip manually between the gear and the pressure lever (Figure # 4).

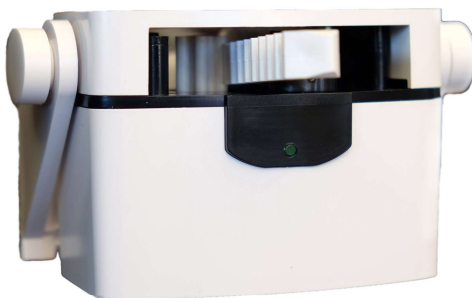

Figure #4: Correctly inserted ridge between the sprocket and the pressure lever

- 8) Use small fixation tips to attach the SMARWI holder carefully with the fingers to the upper edge of the window. , Move SMARWI to the right side to match the mark on the window (Figure # 5), the right side of the ridge holder aligned with right side of SMARWI holder. This ensures that the ridge is perpendicular (90° angle) to the window frame when the SMARWI is glued. The slight deviation from the ideal 90° angle should be compensated for by the device design.

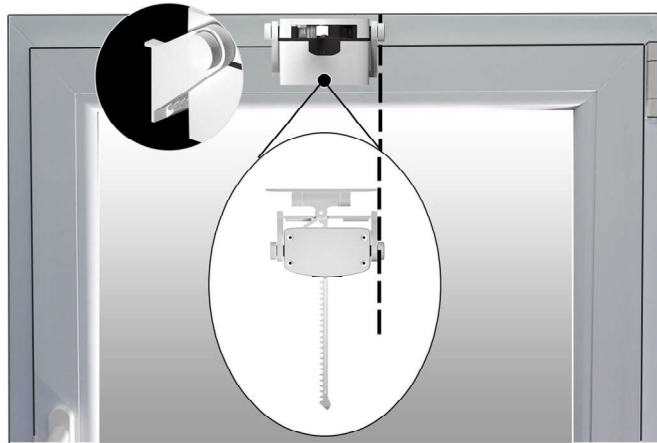

Figure #5: Glued SMARWI with holder

(Detail 1 – fixation tips / Detail 2 – right side alignment of ridge & SMARWI holder)



Important note: Adhesive tapes reach full fixation force after 24h from gluing. After sticking, wait for at least an hour, ideally longer before you start setting and operating SMARWI. If any part of the device has failed to stick correctly, remove it and clean all parts that remained on the window. Order a replacement adhesive kit at www.vektiva.com. First apply replacement tape to holder. Then repeat the process. Do not use adhesive tape other than from vektiva.com.

- 9) If required, fasten the already mounted SMARWI holder using the screws, drilling into the window frame through the holes in the holder. To gain access to these openings, you must rotate SMARWI upside down. These screws are not equipped with cover caps.

- 10) Set the crank to ventilation mode and try to open and close the window manually.

SMARWI and the ridge are now placed on window. Now we will place the cable holders, stick Safety control Box (ScB) and insert SMARWI power supply, see points 11 and 12.

- 11) When attaching the cable holders, proceed from SMARWI towards ScB. Don't set the cable leading from SMARWI to first cable holder too tight. SMARWI should be able to swing in the joint. If you have window with left hinges, you can use slot in SMARWI holder to guide the cable. Even in this case, allow SMARWI to swing.

Think about where you put the security button. Decide whether you will stick the security box vertically along the hinges of the window or horizontally to the bottom of the inner frame (Figure # 6). The BoB bottom part, which is detachable and connected to the BoB magnet, is intended to be glued. If the window opens directly against the wall niche, we recommend placing the BoB on the lower frame well away from the hinges so that it does not get damaged when the window is fully opened.

Place remaining cable holders evenly from SMARWI till ScB (Figure #6)



Figure #6: Two ways of placing ScB and cable leading ways

Inside the ScB, you can shorten the cable by winding it to the required length (Figure #7).



Important note: Before you attach bottom removable part of ScB, be sure to choose right orientation (based on pin, see Figure #7).

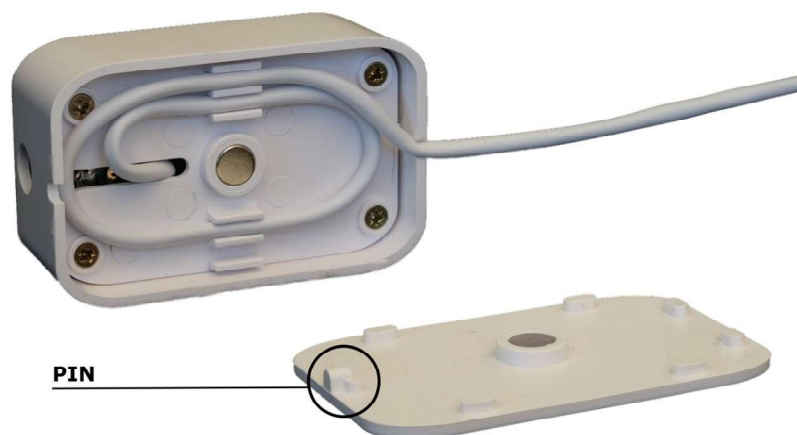



Figure #7: Cable shortening into spiral inside ScB. Removable magnetic bottom part

If necessary use cable holders also to fix adapter cable according your individual situation. The cable length of the adapter is 1.5m. There are extension cables in lengths of 1.5, 3 and 5 meters available at our e-shop at www.vektiva.com. Another option is to use socket extension cable to move socket closer to window with SMARWI.

- 12) Connect adapter cable to the ScB and insert adapter into the socket. SMARWI will blink couple of times. Now the installation is complete and the device is ready for software setup using your mobile device or PC as described in [Chapter 6. Control and Maintenance](#).

6. Control & maintenance

-  To control SMARWI, you will need a PC or mobile device capable of communicating via Wi-Fi.

Please read the following instructions to setup SMARWI correctly. Detailed and up-to-date instructions for SMARWI software control can be found at www.vektiva.com.

1. Initial setup

-  SMARWI is equipped with a Wi-Fi module that works in two modes:

Access point mode (AP – you are connecting directly to SMARWI), allows basic SMARWI control if you are in its physical proximity and serves primarily for initial setup.

Client mode (SMARWI is connected into your local network and internet) allows you to fully control your SMARWI from anywhere and allows you to use advanced features.

1.1. Sign up for vektiva.online service

If you plan to control SMARWI outside of your home, the first step is to register at [Vektiva Online](#). Once registered at vektiva.online site, please note SMARWI identification details: Remote ID and Remote Key. You will need these identification details in the next step and they are valid for all your SMARWI devices.

1.2. First time you will connect with SMARWI in AP mode

When SMARWI is first time turned on, it creates a custom Wi-Fi network (AP mode) for you to connect. Find a network on your mobile device or computer named as **SWR-******* (You will see letters & numbers specific for your SMARWI instead of asterisk).

Use **12345678** password to connect SMARWI AP network

In the web browser, enter into URL (where you normally enter the URLs like www.google.com) IP address: 192.168.1.1

A graphical interface for SMARWI control is displayed. You can now control, plan, and calibrate your SMARWI in AP mode, however only if you are close to its network reach. Also, advanced features are not available in this mode. SMARWI will automatically set the Wi-Fi Mode item to Client mode after restart. If you want SMARWI to work permanently in AP mode, change this setting to AP and confirm with “Save” button.

However, we recommend that you continue to set up SMARWI in Client Mode (Wi-Fi mode set to Client) by connecting SMARWI to your local network and the Internet.

1.3. Local network and internet connection setup (Wi-Fi Mode: Client)

Use the arrow at the top right of the SMARWI box to select Settings from the drop-down menu. In the Basic tab, fill in following items:

- **Device Name** – choose a name for each SMARWI to make it easy for you to recognize which window in your household you are currently managing (such as SMARWI – Bedroom)
- **Wi-Fi Mode** - if it is not in Client mode, switch the SMARWI from AP mode to Client
- **SSID** – choose the name of your home network
- **Password** – fill in the password to access your home network

The following two items are used for registration int Vektiva Online. Use the registration details you obtained in step 1.1 Registration for Vektiva Online.

- **Remote ID** – fill in the Remote ID that you obtained when registering for Vektiva Online
- **Remote Key** - Fill in the Remote Key you earned when signing up for Vektiva Online

Save this setting using the Save button. SMARWI will switch to Client mode within a minute and logs in to your home network. If the Internet is available, it also logs into Vektiva Online. Connecting your PC / mobile device directly to the SMARWI Wi-Fi network (AP mode) ends. Switch your PC / mobile device to connect to your home network / Internet.



Important notice: You can return to AP mode again using ScB, see chapter Security control Box functions. In case of disconnecting/reconnecting the SMARWI to power, your settings remain stored.

1.4. Verify successful switch to Client mode and sign in to Vektiva Online

Make sure your SMARWI is connected to power source.

Sign in to vektiva.online using your login information. If the settings in step 1.2 were successful, you will see your SMARWIs online and you can control it via your account from anywhere you have access to the Internet.

If you don't see your device, switch SMARWI back to AP mode by using the Security control Box button, see chapter 2. and repeat the setup procedure. Verify that all of your login information is correct. Save the settings and then restart by disconnecting SMARWI from the power supply. In case of persistent problems, visit www.vektiva.com for detailed troubleshooting information in the support section or contact us. For a quick overview of SMARWI control methods, see the table below.

Control options	Description	Web interface	API
ScB Button	Your physical presence is required at the window, see ScB button functions	NO	NO
Direct connection to SMARWI Wi-Fi (Wi-Fi Mode: AP)	The user is within range of the Wi-Fi network that SMARWI creates and is connected into it. This mode is primarily intended for initial setup or for change of basic settings. Only basic control functions (opening, closing and one-off planning) are available.	Limited	NO
SMARWI control over local network (Wi-Fi Mode: Client)	The user is within range of his home Wi-Fi network and is logged in. You access SMARWI using its IP address via URL (you can find the SMARWI IP address using your Wi-Fi Router or in Settings/ Info - Local IP address at vektiva.online). Only basic control and plan settings are available.	Limited	YES
SMARWI control via vektiva.online (Wi-Fi Mode: Client)	The user is registered in vektiva.online and SMARWI is registered with a user ID and a key. SMARWI is available on vektiva.online site under the user account from anywhere anytime. All control functions, automatic updates, and WebAPI features are available	Full	YES

1.5. Calibration, control & planning

Before you start using SMARWI, please start with calibration according to the instructions using the Settings / Calibration tab. We are constantly trying to improve the SMARWI user interface according to your suggestions. For this reason, you will find up to date instructions on calibration, control, scheduling & event setup, software updates, and use cases always at www.vektiva.com.

2. Safety button functions



The ScB allows you to control your window manually and above all, it serves as a safety feature in case you need to immediately interrupt window opening or closing. Therefore, it must always be placed in such a way that the Safety control Box is easily accessible (see [Chapter 5. Installation](#)) and follow the safety instructions (see [Chapter 4. Safety instructions](#)) when using SMARWI.

ScB has the following functions:

- **One short press** of a button has more functions depending on the current state of your SMARWI. The press is indicated by a brief flash. See the ScB summary table below.
- **Double click**
It combines consecutive functions of a short keypress, for example, when the closed window is unfixed, it fixes it and starts to open.
- **Longer button press (approx. 2sec)** will cause SMARWI to activate or deactivate your current schedule. This is the same as Run Plans / Pause Plans in the web interface. You can use this feature, for example, if you want to suspend automatic ventilation according to the schedule and close the window with the crank (e.g. in the case of poor weather conditions, etc.) Alternatively, if you want to run the execution of the plan again.

- **Long button press** for 10 seconds will activate access to setting in the AP Mode. To log in, use the password: 12345678 and 192.168.1.1 again in the browser. To exit the AP mode, restart SMARWI using the Reboot button in Settings or disconnect from the power supply.

Button actions	SMARWI initial state	Action result	Indication
One click	Window fixed & closed	Window opening	3 flashes
One click	Window fixed & open	Window closing	3 flashes
One click	Window not fixed	Window fixation	3 flashes
One click	Window is moving	Motion stop & window release	Short interruption flashes for 2 seconds duration
Double click	Window fixed	Window release	Short interruption flashes for 2 seconds duration
Double click	Window not fixed and open	Window fixation and closing	3 flashes
Double click	Window not fixed and closed	Window fixation and closing	3 flashes
Hold for 2 sec	Plans active (running)	Planes stopped	One fast flash sequence
Hold for 2 sec	Plans paused	Planes activated	Two fast flash sequences
Hold for 10 sec	N/A	SMARWI will switch into AP mode	

3. Error states

In some cases your SMARWI may get into an error state. To switch from error mode to normal mode remove the cause of the problem and briefly press the ScB button or confirm the error by using the OK button on your SMARWI tab in the web interface.

Error state examples:

- A locked or jammed window in the frame causes the SMARWI get into error state
- If SMARWI attempts to close the window for a long time, it indicates a problem and goes into an error state.

SMARWI indicates the network connection problems in different modes using indication diode, for details see the table below:

State	Indication
Client mode, SMARWI is not able to connect to the network	2 flashes (repeated approx. 1time per 3 seconds)
Client mode, SMARWI is connected to the network but without IP address assignment. (e.g. DHCP related problem)	3 flashes (repeated approx. 1time per 3 seconds)
AP mode, SMARWI in AP mode	4 flashes (repeated approx. 1time per 3 seconds)
Actions triggered by Safety button	See the Safety button action table
SMARWI not connected to vektiva.online	No diode indication available. SMARWI not connected in vektiva.online will not appear/is grey in vektiva.online control center GUI

4. Maintenance



SMARWI is designed not to require the use of oil or other lubricants. We recommend that you regularly remove dust from the device using a dry cloth. Use the appliance in accordance with the above recommendations.

Due to significant changes in temperature for example as part of seasonal changes, window geometry and sealing ability may change. This is a natural phenomenon, and in order to optimize SMARWI function perform recalibration of the device.

Key to proper operation of SMARWI is the smooth opening of window ventilation. SMARWI may work in a limited or erroneous way if window ventilation movement requires a lot of strength. Please pay attention and regularly check the functionality of your window.

For more information about maintenance and calibration visit www.vektiva.com



Information: To improve the efficiency of your window seals (draft, sound and thermal insulation), it is possible to use a special additional seal for the existing window seals.

7. Examples of use



With SMARWI, you are able to control ventilation of your window remotely and on schedule. Thanks to this, SMARWI can be used for regular and controlled supply of fresh air to designated areas, temperature control, moisture / water penetration through a ventilated window, air flow control, micro ventilation adjustment, outer noise reduction, and control of other influences associated with external factors surrounding your household or commercial building.

There are many ways SMARWI is used and you, our customers are still finding new ones.

Get inspired by other users at www.vektiva.com

8. Disposal instructions



Dispose of the product in accordance with the applicable disposal of electrical appliances law.

9. Warranty



SMARWI manufacturer provides free repair service based on following warranty conditions:

- The product warranty is applicable for 24 months from the date of sale to the consumer
- The warranty covers defects proven to be caused by defective material, manufacturing defects or poor manufacturing performance
- The product has been used in accordance with the instructions and for the purpose intended by the manufacturer, has not been mechanically damaged, has been installed in accordance with the instructions and has not been modified
- The product has a security seal. When handling, avoid damaging it. Damage to the seal will void the warranty of this product

10. Technical specifications

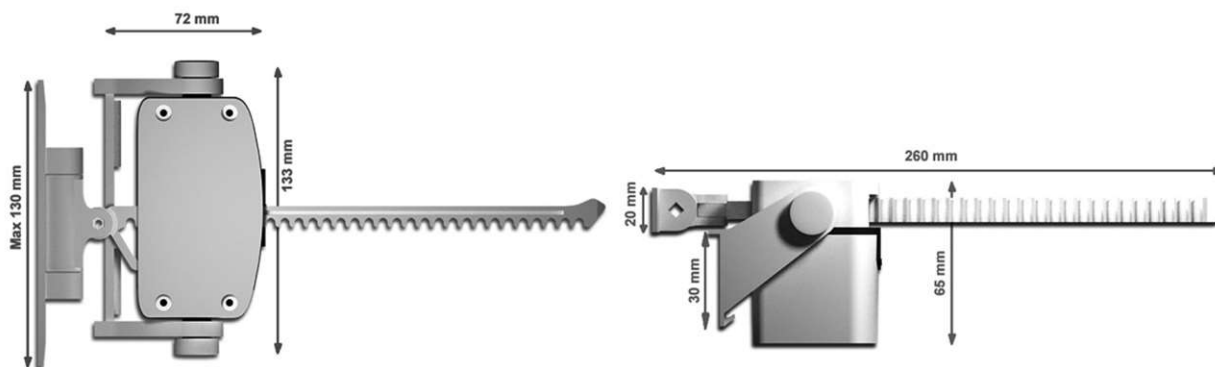

Parameter	Specifications	Additional information
Power Adapter	Input: AC 50Hz/230V Output: DC 12V/1,5-2A	Adapter type C, cable length 1.5m, Accessory extension cable of 1.8m, 3m and 5m is available in the e-shop
Speed of movement	Optional: approx. 3-20 seconds	Approximate time needed to close / open the window
Range of operating temperatures	-5° to + 40° Celsius	Minimal and maximal operating temperatures
Communication standard	Wi-Fi	802.11 b/g/n

11. Service & accessories

To get up-to-date information about the service and accessories available, please visit <http://www.vektiva.com>

We wish all users many pleasant moments as well as stay in healthier and fresher environment while using their SMARWI.

Sincerely Vektiva



Manufacturer: Vektiva s.r.o. Rezlerova, Praha 10, 109 00, Czech Republic, info@vektiva.com

